

Lab-Info

AUGUST 2015 A Bi-MONTHLY BUYER'S GUIDE FOCUS ON LABORATORY & SCIENTIFIC INDUSTRY

LABTRONICS



(An ISO : 9001:2008 , CE Certified Company)



Atomic Absorption Spectrophotometer

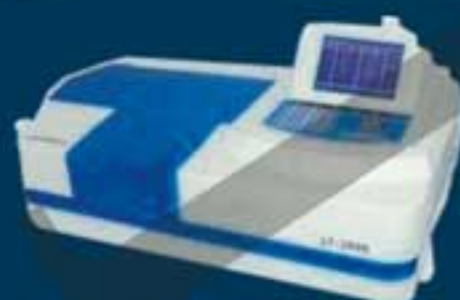

Double Beam UV-VIS Spectrophotometer



Single Beam UV-vis Spectrophotometer



Graphical Display pH Meter



PCR Thermal Cycler



Digital Viscometer



Digital Colony Counter

Plot No. 76, Industrial Area, Phase - II, Panchkula - 160019 Haryana - INDIA, Unit-II: Plot No. 81, HSIIDC, Industrial Growth Center, Barwala, Panchkula INDIA Phone: +91-172-2594773, 5048491, Mobile : +91-9814177389, 9417194330, Email : info@labtronicsindia.com, Website : www.labtronicsindia.com

SEE PAGE 5

OPTSCOPESTM
www.optscopes.com

Biological Microscopes
Stereo Zoom Microscopes
Image Analysis Camera & Software



SEE PAGE - 3



SHIV INSTRUMENTS

We Deals in School, College & Industrial Items

COMPLETE LABORATORY FURNISHERS



Magnifiers



Blood Cell Counter



Stop Clock



B.P. Apparatus



Centrifuge



Student Microscope



Test Sieves



Stand & Clamps

65-UA, Jawahar Nagar, Delhi-110007 (India), Tel.: +91-11-23854451, 23853299, Mob.: +91-9212015661, Email: shivinst@yahoo.com

See 8 Page

NEXT ISSUE LAUNCH IN /BOOK YOUR ADVT. TODAY



6-8 October 2015, MALAYSIA



October 8 - 10, 2015 Hyderabad



17-19 December 2015



1-3 December 2015, Mumbai



18-20 Feb 2016 Nairobi



20-23 Mar 2016 DUBAI

ScientexTM

Scientex



A Quality Products of Scientex



C.B.R. Apparatus



Compression Testing Machine



Aggregate Impact Tester



Lab Cement Autoclave



Ro Tab Sieve Shaker



Sieve Shaker



Hand Sieve Shaker

T-508, Chamelian Road, Behind Filmistan Cinema, Delhi-110006 (INDIA)
Telefax.: +91-11-23527188, Mob.: +91-9811506608
Email: scientex508@gmail.com, Web: www.scientexlab.com

SEE PAGE 6

SCIENTIFIC SOLUTIONS

An
ISO:2008
Certified Co.

Manufacturers & Exporters of
All Kinds of Engineering Instruments, Laboratory Glassware,
Plasticware & Scientific Instruments



C. R. O



FREQUENCY DIVISION
MULTIPLEXING DEMULTIPEXING



MICROWAVE
TEST BENCH



PLC BASED
PNEUMATIC TRAINER



Francis Turbine



CALIFORNIA
BEARING RATIO APP.



DIRECT
SHEAR APP.



VICAT
NEEDLE APP.



THREE HINGED
ARC APP.



MICROTOME



TISSUE PROCESSOR



PORTABLE AUTOCLAVE



CENTRIFUGE MACHINE



HOT AIR OVEN



MATHEMATICAL FIGURE



ELECTRICAL BELL



KLINOSTATE



MICROSCOPE



LABORATORY
GLASSWARE

Shop No 38, F/F, Nandi Devi Dharmshala Complex, Science Market, Ambala Cantt – 133 003 India
Phone No: +91-171- 4003403, Mobile : +91-9466745403 / 9253787460
Email : scientificsolutions38@gmail.com, kumarhitesh1989@gmail.com
Web. : www.scientificsolution.co.in / www.engineeringlabsolutions.com



PURI SCIENTIFIC WORKS

3523- TIMBER MARKET, AMBALA CANTT - 133001

Ph. : 0171 - 2640037, Fax : 0171 - 6530314, Mob. : 099960-00314, 092155-00314

E-mail : puriscworks@gmail.com • Website : www.puriscientific.com

AnISO

9001:2008

CERTIFIED COMPANY

Manufacturer & Suppliers of:-

ELECTRONICS, ELECTRICAL, MECHANICAL & CIVIL ENGINEERING, LAB EQUIPMENTS, I.T.I. TOOL & MACHINERY

ELECTRONICS LAB



- Electronics Devices & Characteristics
- Demonstration Models
- Digital & Linear Electronics
- NFTL Lab
- Microprocessor Lab
- Amplifiers, Oscillators & Multivibrators
- Transformers & Battery Eliminator
- Instrumentation Lab
- Communication Trainer Kit
- Network Analysis, Theorems
- Microwave Lab
- PCB Lab

ELECTRICAL LAB

- Machine Shop
- Resistive, Inductive, Capacitive Loads
- AC & DC Power Supplies
- Power Electronics Lab
- Control Lab
- Transformers & Battery Eliminators
- Switchgear Protection Lab
- Transmission Lab
- Cut Section Model
- Testing & Measuring Instruments



MECHANICAL LAB



- Applied Mechanics
- Theory of Machine
- Heat Transfer Lab
- Thermodynamic Lab
- Material Science Lab
- Refrigeration & Air Conditioning
- Steam Lab
- Fluid Machine Lab
- Hydraulic Machinery
- Automobile Engineering Lab

CIVIL LAB

- Structure Lab
- Soil Testing Lab
- Concrete Lab
- Survey Lab
- Environment Lab
- Fluid Machine Lab



I.T.I.'s LAB

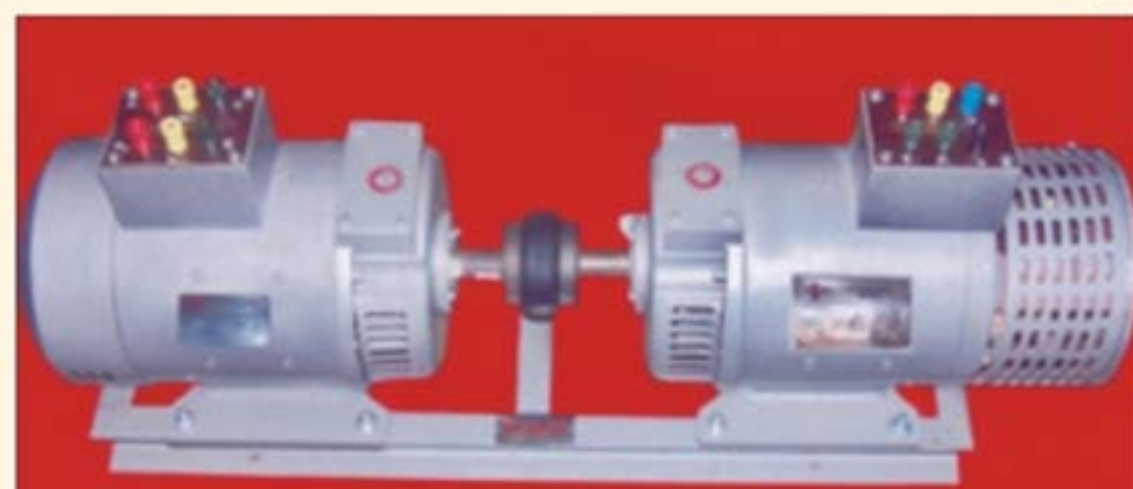

- Electronic Mechanics
- Electrician
- Refrigeration & AC
- Fitter
- Welder
- Carpentry
- Hair & Skin Care
- Diesel Mechanics
- Turner
- Plumber
- Cutting & Tailoring
- Draughtman (Civil)

PURI SCIENTIFIC WORKS





KAY PEE UDYOG

An ISO 9001:2008 Certified Co.

A TRUSTED NAME IN LABORATORY INSTRUMENTS

Manufacturer & Exporter of
all Kind of Laboratory Instruments & Apparatus

Specialized in :-ALL TYPE OF
HEATING & COOLING INSTRUMENTS

COVERING LAB

Pathology Lab,
Research Lab,
Microbiology Lab,
Agriculture Lab,
Food Lab,
Pharma Lab
Medical Lab,
&
Water Lab



HOT AIR OVEN



BACTERIOLOGICAL
INCUBATOR



ENVIRONMENTAL CHAMBER
(STABILITY CHAMBER)



AUTOCLAVE



MUFFLE FURNACE



B.O.D. INCUBATOR
(BIO-CHEMICAL OXYGEN DEMAND)

Office : 3613, Timber Market,
Ambala Cantt - 133001, Haryana, India

Works : No. 101, Industrial Area
Ambala Cantt - 133001, Haryana, India

Tel. : +91-171-2642272, 2699164

Mobile : +91-9896432272, 9896124839

Email : kaypeeudyog@live.com,

Website : www.kaypeeudyog.com

Vaiseshika®

Whenever you think of standards think of Vaiseshika



ISO 17025 : 2005 Calibration Laboratory

Knowledge & Technology driven
Laboratory & Educational Solutions

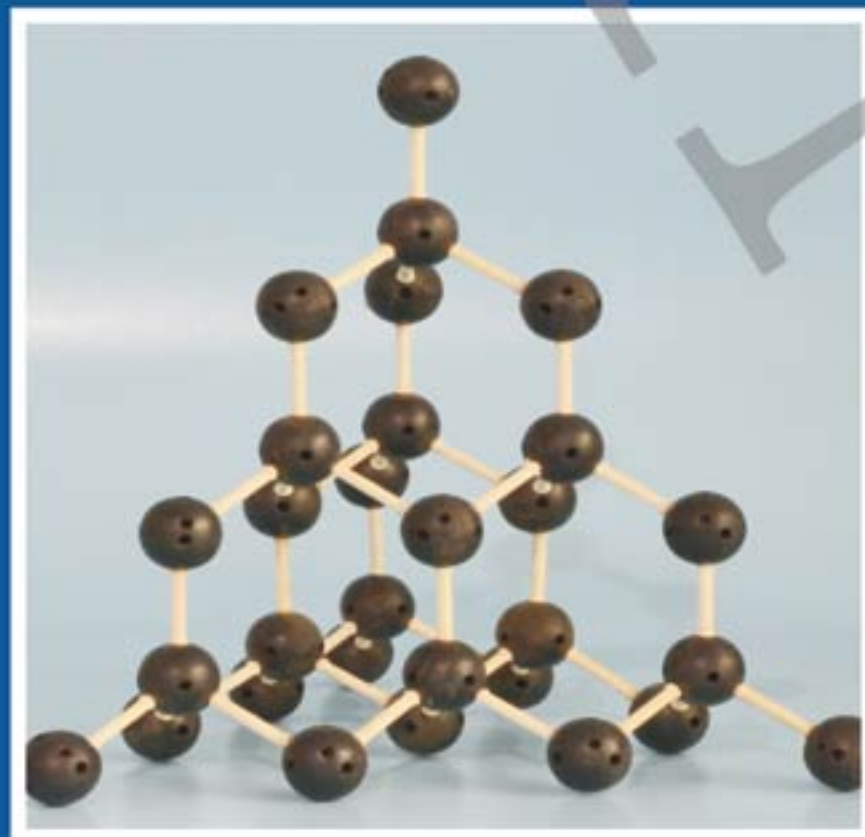
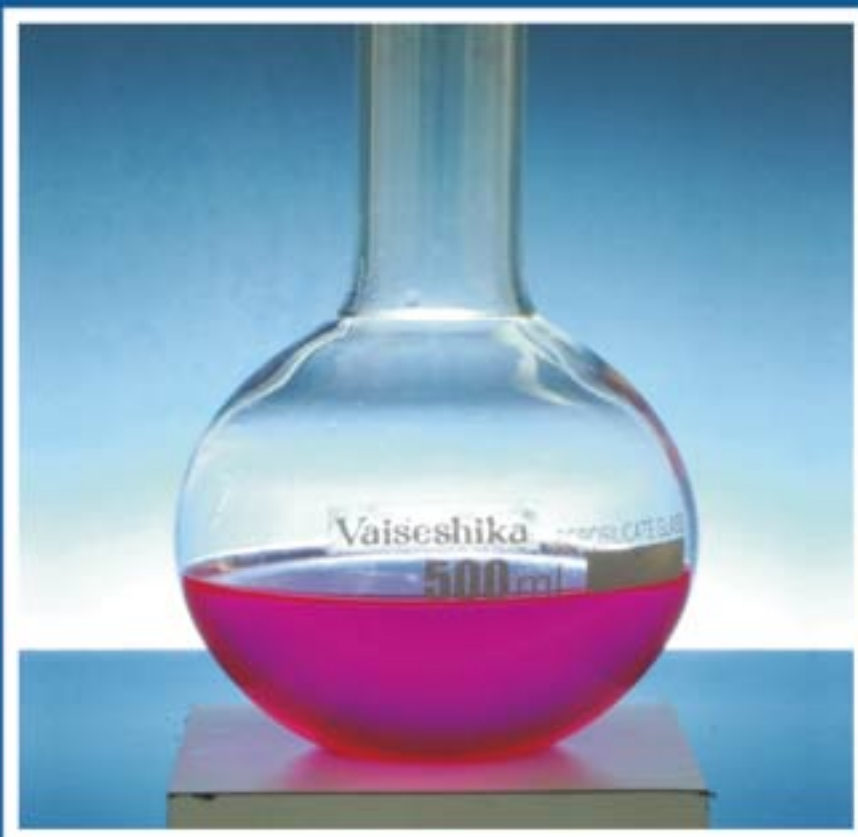

- Physics
- Chemistry
- Biology
- Microscopes
- Calibrated Laboratory Thermometers

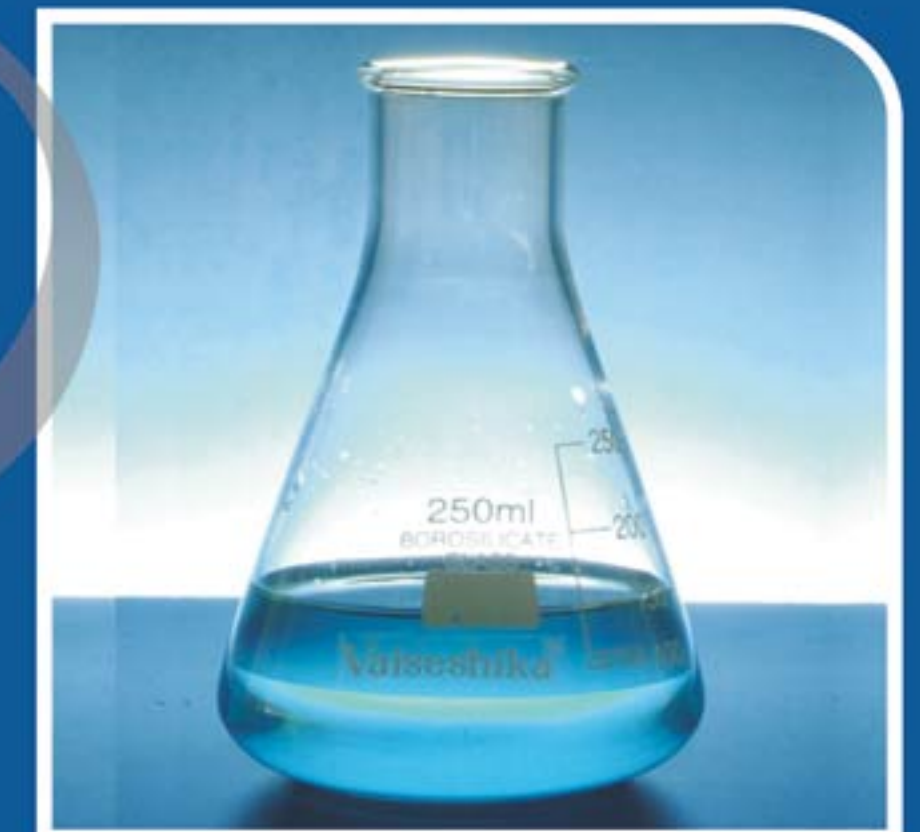

National Award for Prime Minister of India
to President Vaiseshika for quality products



VAISESHIKA INSTRUMENTS PVT. LTD.

38, Industrial Estate,
Across Tangri River Bridge
Ambala Cantt. - 133001 (INDIA)

WhatsApp: +91-9896916789

Phone : +91-171-2699891, 2699827
Fax : +91-171-2699773
Email : vaiseshikalabs@gmail.com
labs@vaiseshika.com
Website : www.vaiseshika.com

Manufacturer of :

Scientific, Laboratory & Pharmacy Instruments



Mortuary Freezer



Mortuary Chamber



Lab/Pharma Refrigerator



**Muffle Furnace
(800°C, 1200°C)**



Blood Bank Refrigerator



**Orbital Incubator
Shaker**



**Deep Freezer
-20, -40, -86°C**



**Upright/Chest Deep Freezer
-20, -40, -86°C**



**Embalming Machine
For Cadavour**



Waste Incinerator



Rotary Flask Shaker



V.D.R.L. Shaker

Biological Microscopes

Stereo Zoom Microscopes

Image Analysis Camera & Software



OPTSCOPESTM



OPTSCOPES MANUFACTURING COMPANY

527, P. P. Puram, Ambala Cantt 133006 HARYANA - INDIA

Mobile : +919729695559, +918222866888

Landline : +911712699225

Email : optscopesindia@gmail.com, info@optscopes.com

f : www.facebook.com/optscopes

Website : www.optscopes.com





**MANUFACTURER'S,
SUPPLIER'S &
EXPORTER'S**



- MECHANICS • PHYSICS • CHEMISTRY
- BIOLOGY • BOROSIL GLASS • SODA GLASSWARE
- MODELS • PLASTICWARE • PORCELAIN
- MICROSCOPES • LAB INSTRUMENT • ELECTRONICS • PHARMACY



GUPTA AGENCIES

5341, Punjabi Mohalla,
Ambala Cantt-133001 (Haryana) India
Tel : +91-171-2643058, 2642016, 4006826
Fax : +91-171-2601357

Gupta's Arcade, Kahsra No 22/1/2/3,
Pallavi Enclave, Near Industrial Area,
Ambala Cantt - 133001 (Haryana) India
Tel :+91-171-2891494, Fax:+91-171-2891490

Email : info@guptaagenciesindia.com, labfab766@hotmail.com

Website : www.guptaagenciesindia.com



LABTRONICS

Manufacturers & Exporters
Analytical laboratory Instruments

(An ISO : 9001:2008 , CE Certified Company)



LT-2100
Atomic Absorption
Spectrophotometer

LT-50
Graphical Display
pH Meter



LT-2900
Double Beam UV-VIS
Spectrophotometer

LT-240
PCR Thermal Cycler



LT-290
Single Beam UV-VIS
Spectrophotometer

LT 730
Digital Viscometer



LT 37
Digital Colony Counter

Plot No. 76, Industrial Area, Phase - II, Panchkula - 160019 Haryana - INDIA
Unit-II: Plot No. 81, HSIIDC, Industrial Growth Centre, Barwala, Panchkula INDIA
Phone: +91-172-2594773, 5048491, Mobile : +91-9814177389, 9417194330
Eml : info@labtronicsindia.com, Website : www.labtronicsindia.com

Scientex™

Scientex

A Quality Products of Scientex



An ISO
9001:2008
Certified
Company



C.B.R. Apparatus



Compression Testing Machine



Aggregate Impact Tester



Ro Tab Sieve Shaker



Sieve Shaker



Bitumen Pentrometer



Bitumen Extractor



Cube Mould



Test Sieves



Jaw Crusher

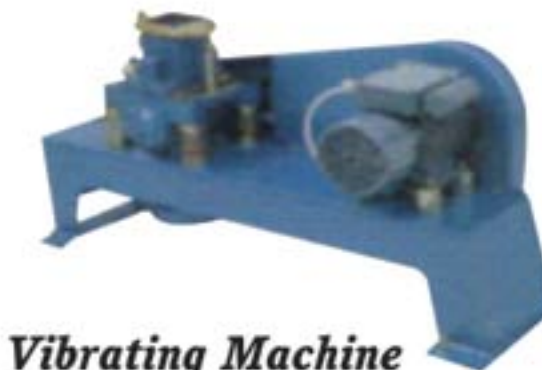

Vibrating Machine



Pulverizer Disc 7"

Manufacturers of: **Material Testing Instruments & Scientific Instruments**

T-508, Chamelian Road, Behind Filmistan Cinema, Delhi-110006 (INDIA)

Telefax.: +91-11-23527188, Mob.: +91-9811506608

Email: scientex508@gmail.com, Web: www.scientexlab.com

HOST

LEADING MANUFACTURER & WHOLESALE SUPPLIERS

COMPLETE SCHOOL & COLLEGE LABORATORY FURNISHING

• Physics & Chemistry Apparatus • Industrial Appliances • Oven • Heating Mantle • Glassware • Plastic wares • Porcelain wares • Rubber wares • Aluminum / Copper ware • Stainless Steel Instruments • Medical & Hospital Equipments • All Type of Retort Stand & Clamps • Electronic & Electrical Instruments • Wooden Apparatus • Map & Chart • Biological Models • Microscopes • Projectors • Alnico Magnet • Autoclave • Compass • Pharmaceutical Instruments • Oil & Petroleum Testing Instruments • pH Electrodes • pH Meter



Digital pH Meter



Polarimeter



Microscope



Clump & Stand



Friability Test Apparatus



Centrifuge



Plasticware



Recording Drum



Zener Diode Characteristics Apparatus



Oven



Vacuum Pump



Buchhi Apparatus

HARI OM SCIENTIFIC TRADERS

5780, Street No. 7, New Chandrawal, Jawahar Nagar, Delhi-110007 (INDIA) Tel.: 011-23851476,

Mob: 9891390316, Email: hostinst@yahoo.co.in, Web: www.hariomscientific.com



Avi Chem Industries

An ISO 9001:2008 Company



MANUFACTURERS & EXPORTERS OF:

Laboratory Chemicals, Analytical Reagents, HPLC Solvents,
Dehydrated Culture Media, Research Chemicals etc..

THE COMPLETE RANGE OF LABORATORY CHEMICALS.....



Correspondence Address:

A-221, Amargian Indl. Complex, Opp. New S.T. Stand, L.B.S. Marg,
Khopat, Thane (w) 400601. (Mumbai), India .
Tel. No. 022-25477638/40, Mob. No. 9323073623, 8879996704

Sales Office:

, Gala No-02, Jai Jalaram Compound, Kalher, Bhiwandi, Dist-Thane
(Mumbai), India .

Email:

md@aviscientific.com

sales@aviscientific.com

URL: www.avi-chem.com



SHIV INSTRUMENTS

We deals in School, College & Industrial Items

Our Main Items

- Pathology Lab Instruments
- Blood Cell Counter
- We Deal in Hospital Goods
- (Esal) Stop Clock & Others
- Rubber Ware Scientific & Surgical Ware
- B.P. Apparatus, Stethoscope
- Milk Testing Instruments
- All Type of Olympus Microscope
- Map & Charts



Meter



Resistance Box



Rheostat



Oven



Portable Autoclave



Student Microscope



Magnifiers



pH Meter

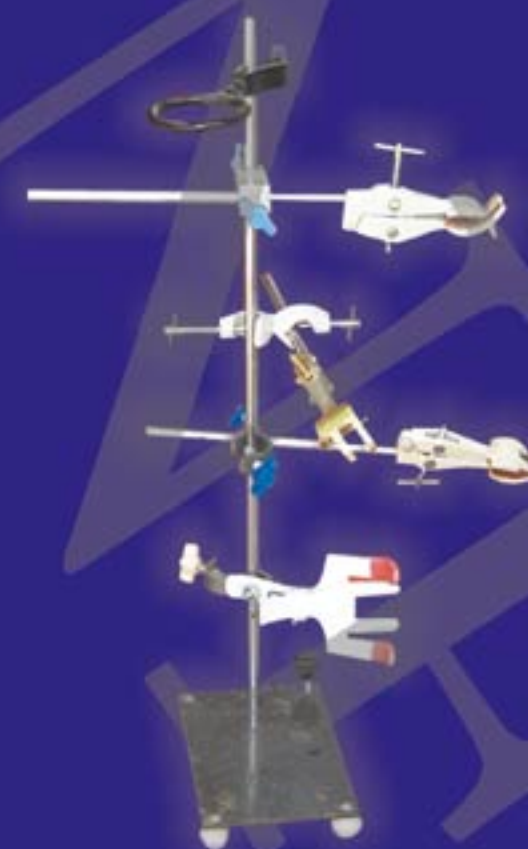

Stand & Clamps

Our Special Items

Magnifiers

Microscopes

Digital / Dimple / Thermometers

Polylabware

Parco Instruments

Dissection Instruments

Telescope Brass

All types of Gloves

J-Brand Porcelain Ware



Study of UJT Characteristics Apparatus



B.P. Apparatus



Centrifuge



Stop Clock



Rubber item



Lab Glassware

COMPLETE LABORATORY FURNISHERS

65-UA, Jawahar Nagar, Delhi-110007 (India), Tel.: +91-11-23854451, 23853299,
Fax: +91-11-23854451, Mob.: +91-9212015661, Email: shivinst@yahoo.com



Precautions for Readers :-

Lab Info is a Trade Directory. Advertisement in this directory by any Name or by any Organisation, whether in the body of the text or in any advertisement, is made in good faith and does not imply that the organisation is accorded by any special standing. So, We are not responsible regarding financial standing and status of the company/firms listed in various pages of this directory.

Readers are advised to take usual commercial precautions.

We have made sincere efforts to collect and include complete, correct and current information in

Lab Info, but does not warranty that any or all of such information is complete, correct or current. We do not assume and hereby disclaims, any liability to any person or entity for any loss or damage cause by errors or omissions of any error. We would appreciate if you would bring such error to our attention.

Readers of **Lab Info** who are interested in dealing with the advertisers should communicate with them directly at their own risk.

All disputes are subject to the exclusive jurisdiction of competent court and forums in Delhi/New Delhi only.

HEAD OFFICE :
2783, 3rd Floor, D. C. Road,
Ambala Cantt-133001 Haryana INDIA

BRANCH OFFICE :
B-151, Street No. 9, Kamal Vihar,
Kamaal Pur, Burari, Delhi-110084 INDIA
Tel. : 011-65252725, Mobile : 09213724926,
Email : Sharad.labinfo@gmail.com
Web: www.labinfo.in



Contact for
Brand Promotion & Advertisement
Mobile : 09213724926
Email : Sharad.labinfo@gmail.com

Print Edition Advertising Rate Card

Format	Dimensions Height x Weight in (mm)	Rate per insertion in INR / US\$
COLOUR - Section		
Front cover (75%)	245 X 185	25,000 / 430
Gate Fold	245 X 185	30,000 / 475
Back cover	245 X 185	22,000 / 400
Second Cover	245 X 185	20,000 / 375
Third Cover	245 X 185	20,000 / 375
Full Page	245 X 185	15,000 / 250
Half Page	120 X 185	8,000 / 125
Quarter page	120 x 90	4,000 / 65
B/W - Section		
Full Page	245 X 185	8000 / 125
Half Page	120 X 185	4000 / 65
Quarter page	120 x 90	2000 / 35
Half Quarter page	60 x 90	1000 / N.A

AN ISO 9001 : 2008 CERTIFIED CO.
PC PULKIT CHEMICALS
SPECIALIST IN : FOOD LAB

**Deals in: All Types of Scientific Apparatus and Instruments,
PC Brand Glass Wares, & All Type of Laboratory Chemicals**



B.O.D. INCUBATOR



AUTOCLAVE



MUFFLE FARNNESS



WATER STILL

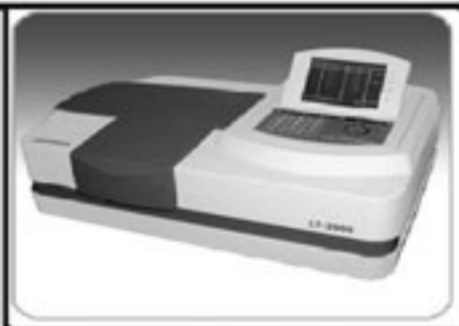

UV- SPECTROPHOTOMETER



HOT PLATE



GLASS WARE



PLASTICWARE



LAB CHEMICALS

5802, Gali No. 7, New Chandrawal Jawahar Nagar, Delhi-110007 INDIA
Telefax: 23858149, Mob: 09811217048 Email: pulkitchemicals@gmail.com
Website : www.pulkitchemicals.com



PURI SCIENTIFIC WORKS

AnISO

9001:2008

CERTIFIED COMPANY

3523- TIMBER MARKET AMBALA CANTT - 133001

Ph. : 0171 - 2640037, Fax : 0171 - 6530314 Mob. : 099960-00314, 092155-00314

E-mail : puriscworks@gmail.com • Website : www.puriscientific.com

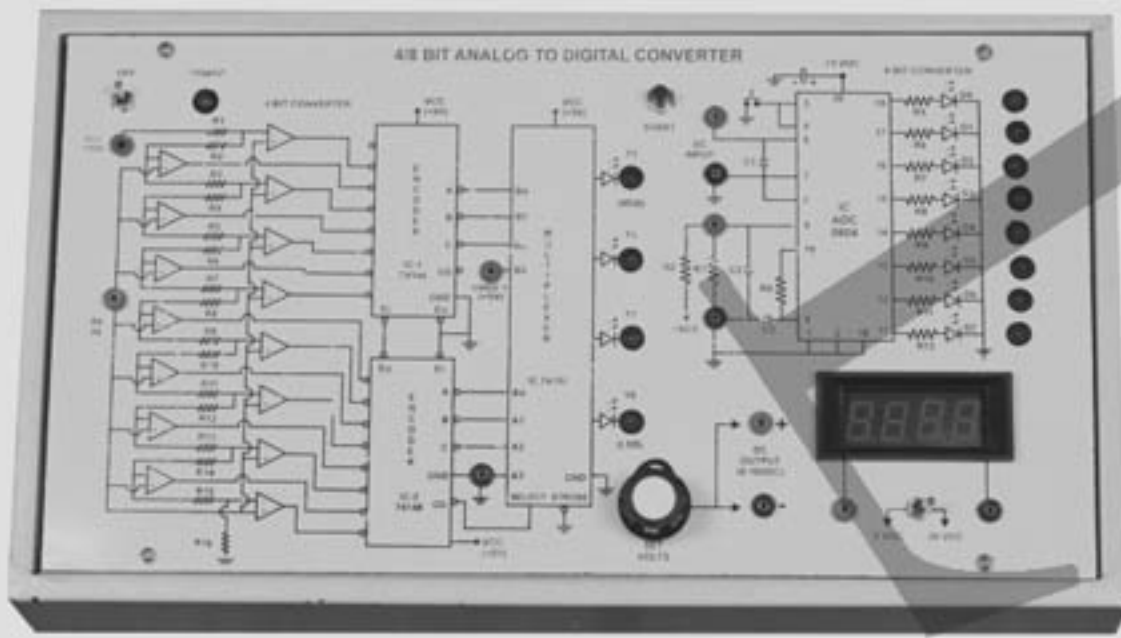

4/8 Bit Analog to Digital Converter

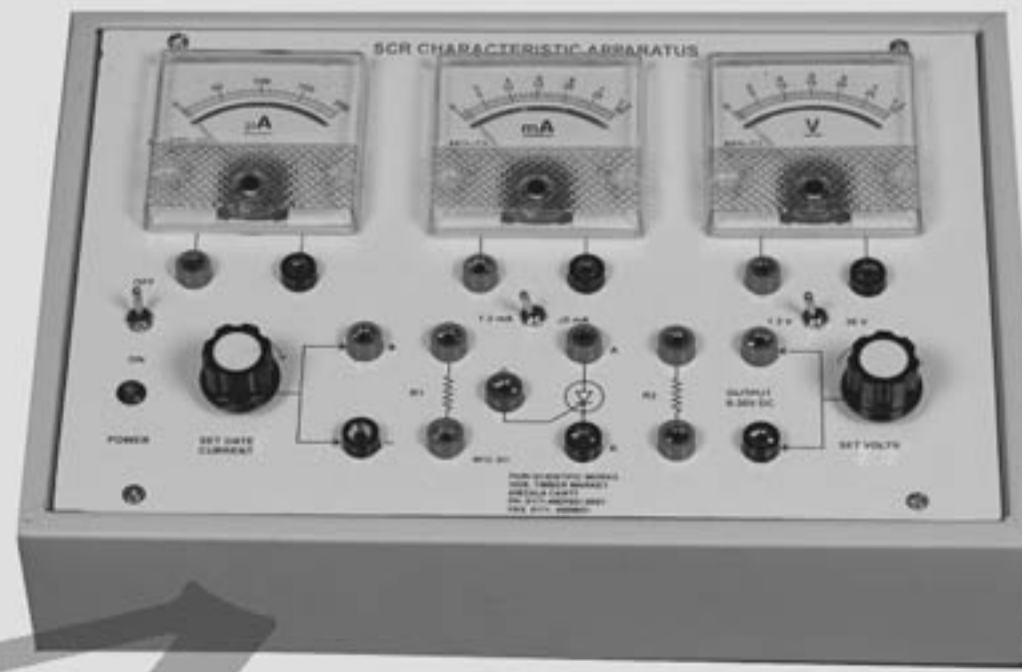

SCR Characteristics Apparatus



C.R.O



Microwave Bench



Power Supply

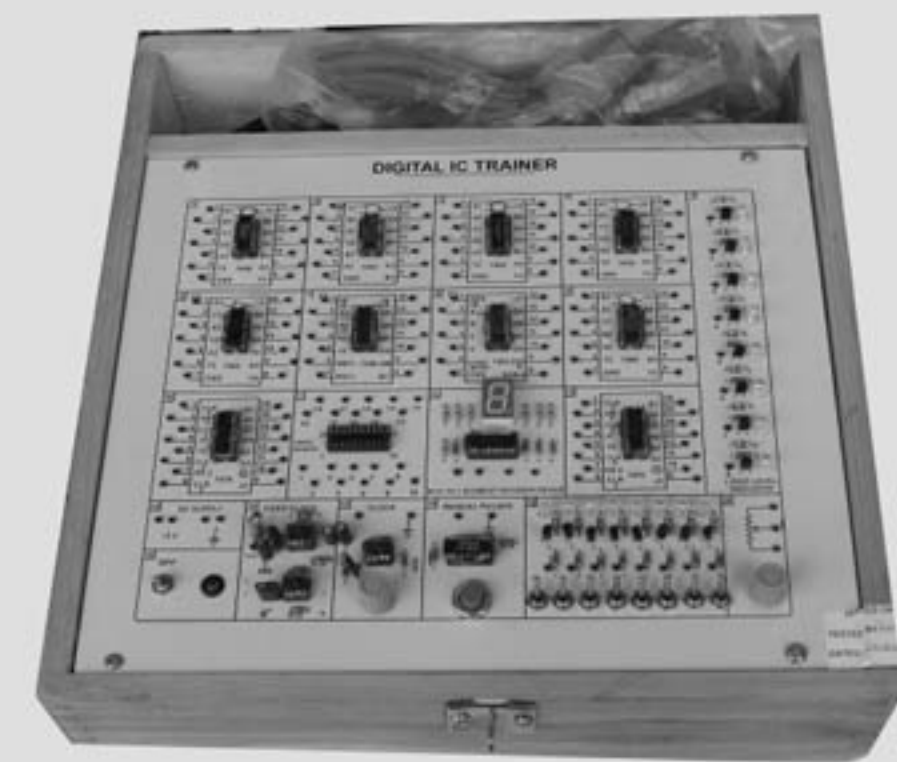

Digital I C Trainer



Antenna Simulator
(Directional & Unidirectional)



Synchronisation of
Alternator with Bus-bar



Percentage Differential Relay



Motor Generator Set



Resistive Load

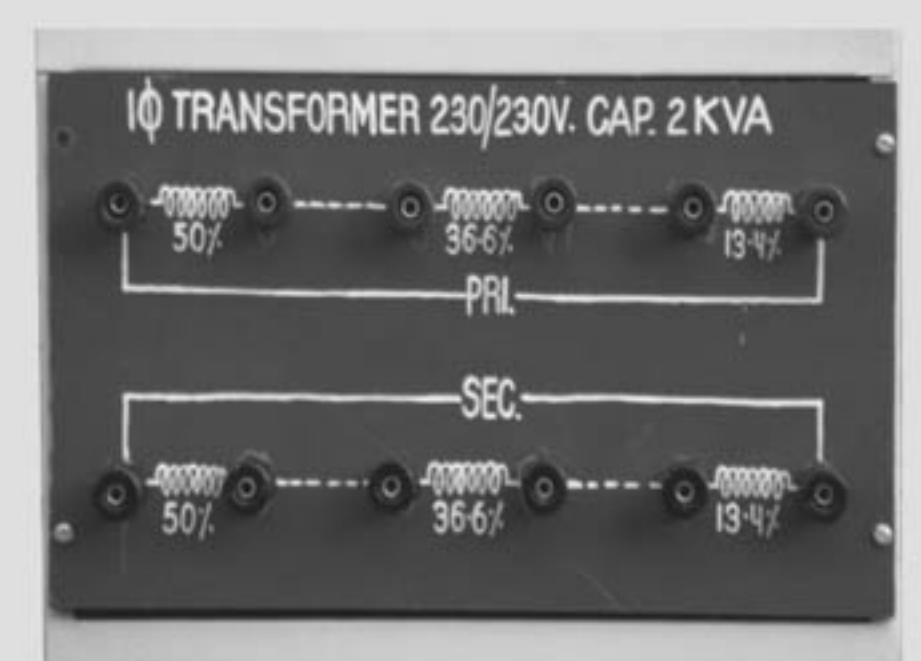

Single Phase Transformer

**Manufacturer & Suppliers of:-
ELECTRONICS, ELECTRICAL, MECHANICAL & CIVIL ENGINEERING LAB EQUIPMENTS, I.T.I TOOL & MACHINERY**

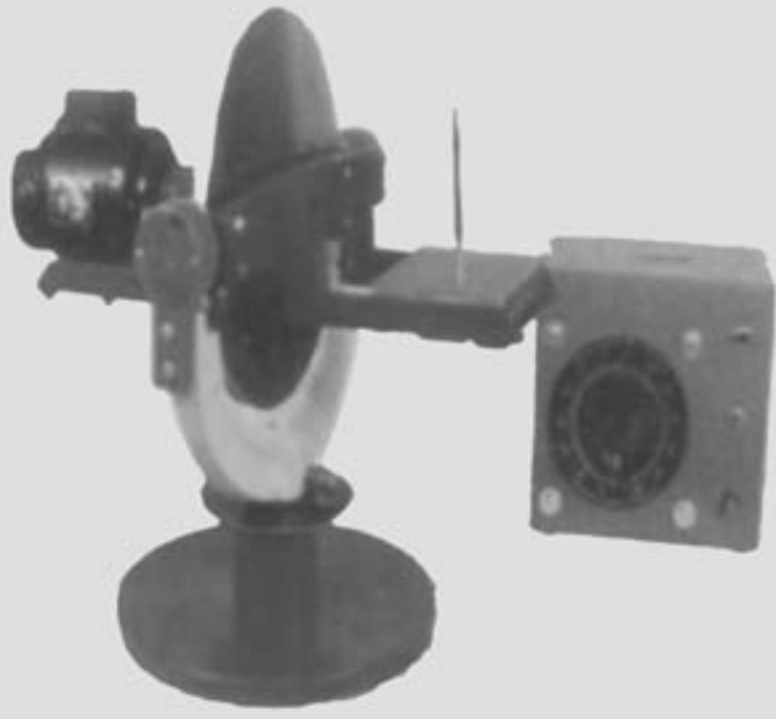

Gyroscope



Thermal Conductivity of Metal Bar

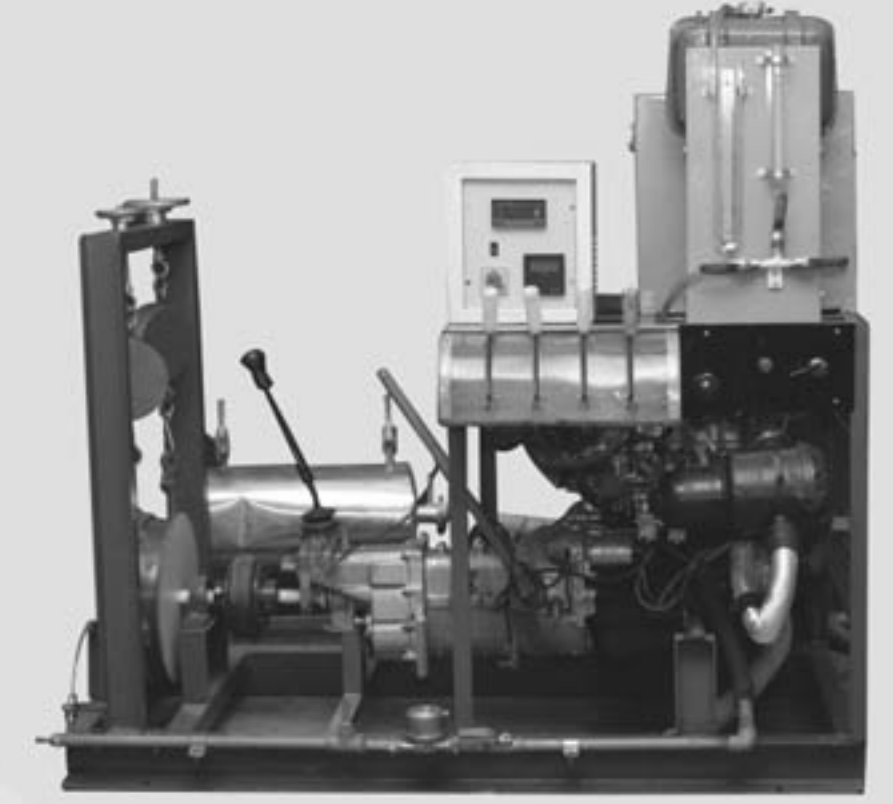

Petrol Engine Test Rig



Refrigeration Panel



Profile Projector



Babcock Wilcox Bioler



Digital Microscope

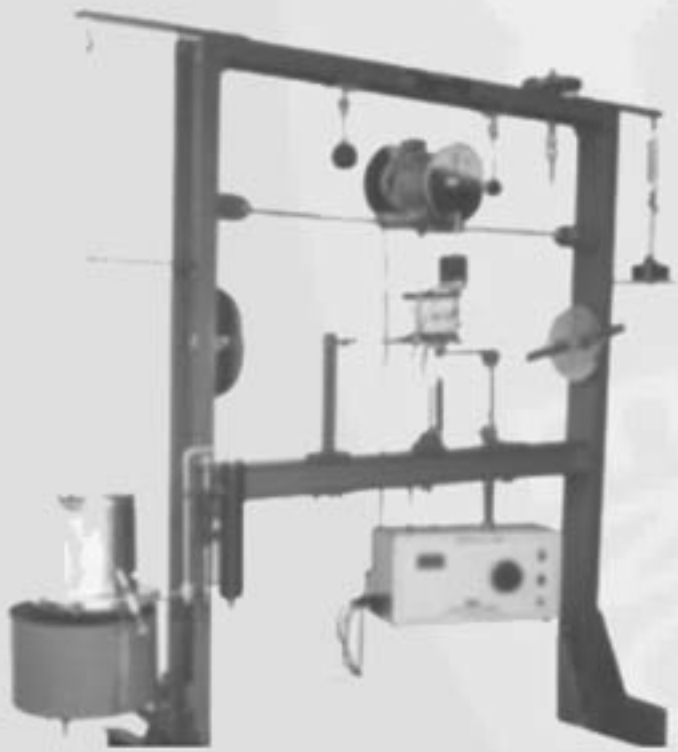

Vibration Apparatus

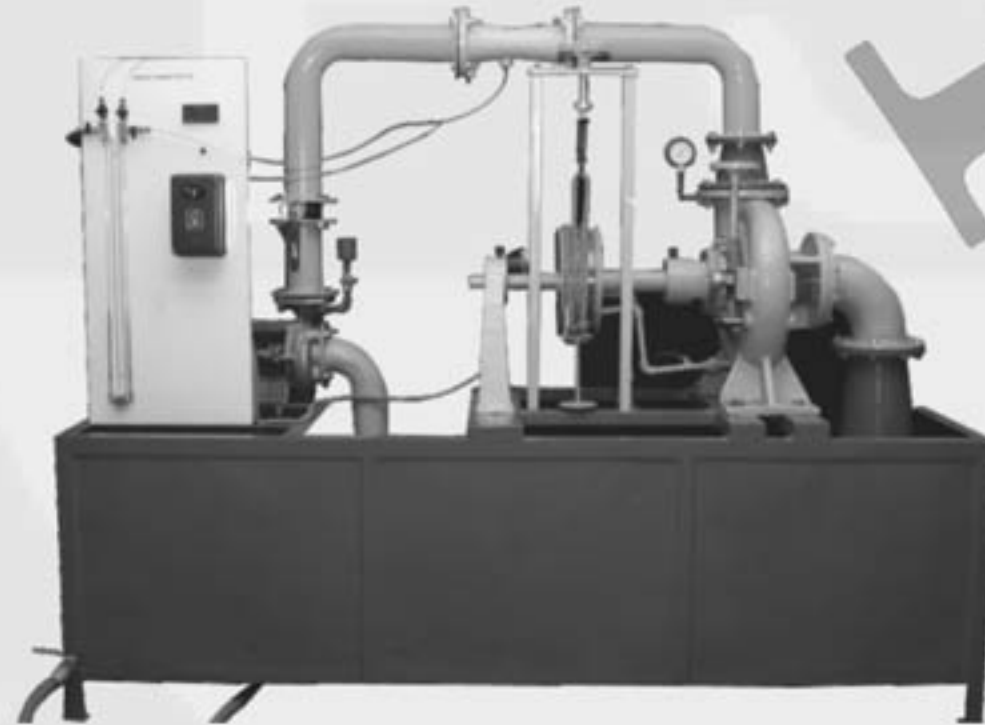

Francis Turbine

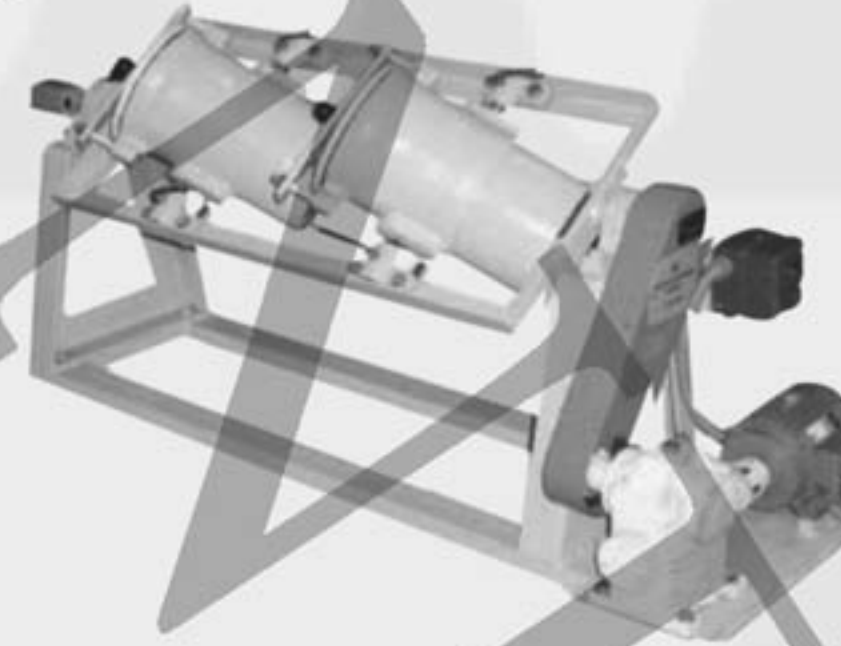

Vee Bee Consistometer



Flow Over Notch Apparatus



Three Hinged Arc Apparatus

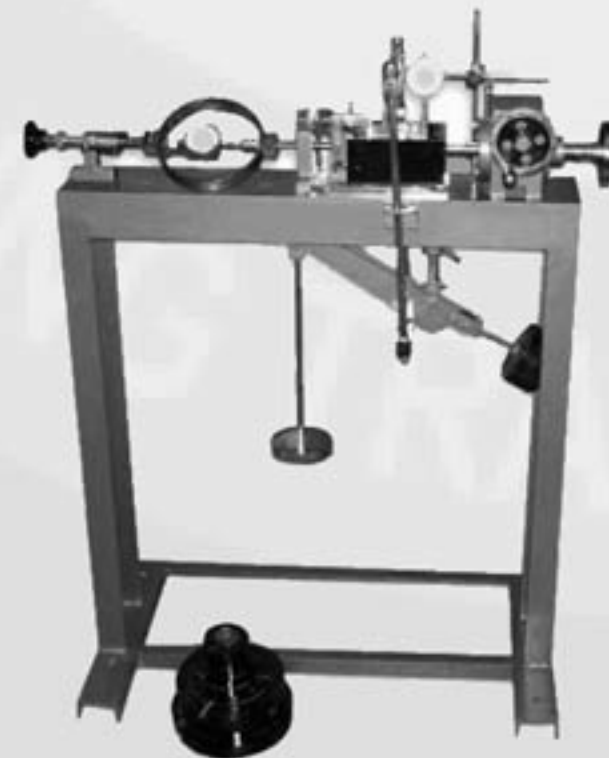

Direct Shear Apparatus



Auto Label

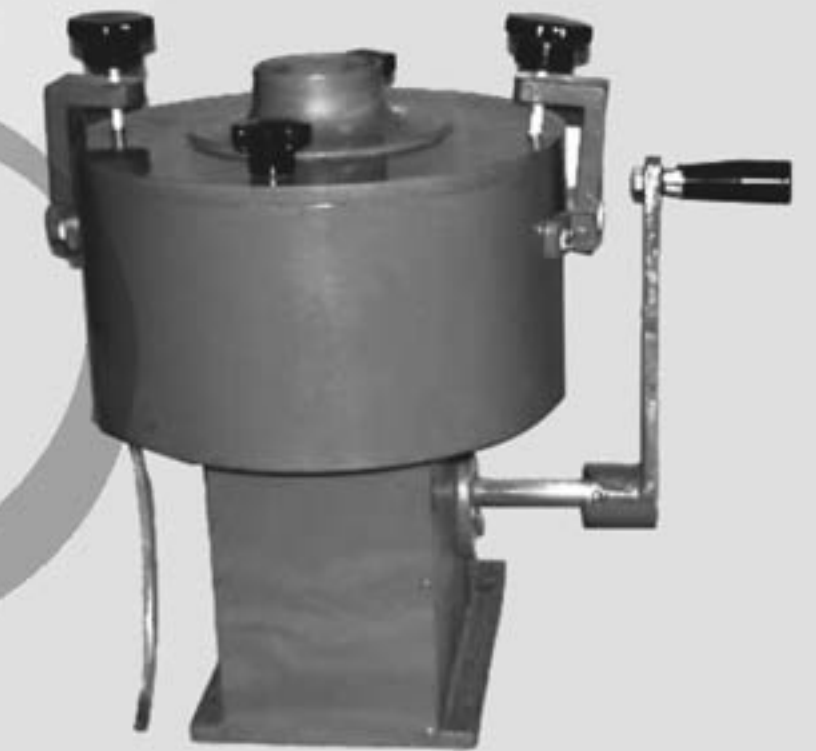

Bitumen Extractor

ELECTRICAL

- Machine Shop
- Power Electronics Lab
- Control Lab
- Switchgear Protection Lab
- Transmission Lab
- AC & DC Power Supplies
- Cut Section Model

ELECTRONICS

- Electronics Devices & Characteristics
- Digital & Linear Electronics
- NFTL Lab
- Microprocessor Lab
- Instrument Lab
- Communication Lab
- Microwave Lab

MECHANICAL

- Applied Mechanics
- Theory of machine
- Heat Transfer Lab
- Thermodynamics Lab
- Material Science Lab
- Ref. & AC Lab
- Automobile Engineering Lab

CIVIL

- Structure Lab
- Soil Testing Lab
- Concrete Lab
- Survey Lab
- Environmental Lab
- Fluid machine Lab

Proven Trade Contacts

www.webptc.com

A MONTHLY PUBLICATION FOR MEDICAL DEVICE INDUSTRY

An international monthly magazine, published since 1992, is available in Hard Copies, On-line, CD and .pdf versions. As the circulation is on worldwide basis, it is imperative on your part to be associated regularly with Proven Trade Contacts.

Get free Digital Version in your mailbox.

To receive e-mail version (.pdf format), register your e-mail address at:

http://webptc.com/ptc_digital_issues.html

Advertisements under headings 'Buyers', 'Sellers', 'Calendar of Events', 'Hospital Directory' and 'Suggested useful websites' are published FREE OF CHARGE

A monthly magazine devoted to the promotion of complete range of Surgical, Medical & Hospital Goods, Laboratoryware & related trade and services.

(Make your Website more popular. Contact us for Banner Exchange)

Ask for free specimen COPY

Channel Partner :



www.careworldtv.com



Narang Medical Limited

(PUBLICATION DIVISION)

Narang Tower, 46, Community Center, Naraina Indl. Area, Phase-1,
New Delhi-110028, India, Tel.: 91-11-45554000 (100 Lines),
Fax : 91-11-45554001 Email : ptc@webptc.com



Visit : www.narang.com | www.surgicalshop.com | www.ortho.in

View digital version online at: www.webptc.com/download

A YEARLY SCIENTIFIC BUSINESS DIRECTORY

Indian Scientificproducts.com
SCIENTIFIC BUSINESS DIRECTORY
(ONLINE & PRINT VERSION - 2013)

WEBSITE / DOMAIN / WEBSITE WEBSITE PROMOTION EMAIL MARKETING

CHADVIA INFOMEDIA
Business Directory (Online & Print Version)
A-117, 2nd Floor, Convent Road, Sector-17, Gurgaon, Haryana, India
Phone: +91-122-4122222 Fax: +91-122-4122222

SINCE 1978 **OPTICS TECHNOLOGY**
(AN ISO 9001:2008 CERTIFIED)
Manufacturer & Exporters of: LABORATORY TESTING INSTRUMENTS

CE Approved ISO 9001:2008

205, DSIDC, J-Dock, Shakurpur, (Opp. Britannia Ind. Ltd.) Delhi-110034 (India) Phone: 0091-11-27101303, 27104450, Fax: 0091-11-27108590, E-mail: info@optics-technology.in, Website: www.optics-technology.in

INDIA A POPULAR SCIENCE APPT. WORKSHOP'S PVT. LTD.
MANUFACTURER • EXPORTER • IMPORTER

SPAN AUTOMATION
ADVANCE MICROPROCESSOR LABORATORY CONTROLLERS

DHAMI ENTERPRISES
An ISO 9001 : 2008 Co. Zoner Page No. 50

J.R. SCIENTIFIC INDUSTRIES
MANUFACTURER OF: SCIENTIFIC, LABORATORY & PHARMACY INSTRUMENTS

SUPER TECH INSTRUMENTS
MANUFACTURER OF: SCIENTIFIC, LABORATORY & PHARMACY INSTRUMENTS

RABAL
Since 1987
RABAL ELECTRICAL SYSTEMS
Email: info@rabalelectrical.com Website: www.rabalelectrical.com Zoner Page No. 52

**YOU
CAN
PRODUCTS
&
CATEGORY
WISE
SEARCH**

Print Edition Advertising Rate Card

Format	Dimensions Height x Weight in (mm)	Rate in INR / US\$
COLOUR - Section		
Front cover (80%)	245 X 185	75,000 / 430
Back cover	245 X 185	60,000 / 400
Second Cover	245 X 185	30,000 / 375
Third Cover	245 X 185	30,000 / 375
Full Page	245 X 185	15,000 / 250
Half Page	120 X 185	8,000/125
Quarter page	120 x 90	4,000/ 65
B/W - Section		
Full Page	245 X 185	8000/125
Half Page	120 X 185	4000 /65
Quarter page	120 x 90	2000 /35
Half Quarter page	60 x 90	1000/ N.A

BUSINESS EXIM (INDIA)

**B-151, Gali No. 9, Kamal Vihar, Kamaal pur, Burari, Delhi-110084 (India), Tel.: +91-11-65252725,
Mob.: +91-9213724926, Email: sharad.labinfo@gmail.com, Web: www.indianscientificproducts.com**

UPCOMING EXHIBITIONS

Thailand Lab 2015

9-11 September 2015, Bangkok
For Further Details: VNU
Exhibitions Asia Pacific
Web: www.thailandlab.com

Lab Asia

6-8 October 2015, Kuala Lumpur, Malaysia
For Further Details: ITE Group
Email: enquiry@ecmi.com.my
Web: www.lab-asia.com

India Lab Expo 2015

8-10 October 2015, Hyderabad, India
For Further Details: MMI India Pvt. Ltd.
Email: saiprasad.terde@mmi-india.in
Web: www.analyticaindia.com

Lab Complex 2015

13-15, October 2015, Kyiv, Ukraine
For Further Details: IFCS Laboratories
Web: www.pharmcomplex.com

P-MEC India

1-3 December 2015, Mumbai, India
For Further Details: UBM India
Web: www.cphi-india.com

Nepal Lab

17th to 19th December 2015, Kathmandu, Nepal
For Further Details: S D Promo Media
Email: info@nepallab.com
Web: www.nepallab.com

Kenya Laborum

18th to 20th February 2016, Nairobi Kenya
For Further Details: S D Promo Media
Email: gunjan@sdpromomedia.com
Web: www.kenyalaborum.com

ARAB LAB THE EXPO

20-23 MAR 2015
Dubai International Convention & Exhibition Centre Dubai, United Arab Emirates
For Further Details: www.arablab.com

FOR ALL TRADE FAIR ORGANIZERS:

Promote your Trade Fairs and Exhibitions through our Buyer's Guide worldwide. Ask for detailed proposal.
sharad.labinfo@gmail.com

READER'S FORM

LAB INFO

A Bi-Monthly Buyer's Guide Issue Focus On Educational, Laboratory & Scientific Industry

Please Tick:

A) *Free copy of Buyer's Guide at your doorstep

C) Book Advertisement in Buyer's Guide

B) Free Digital copy of Buyer's Guide by Email

Company Name _____

Contact Person: _____

Address: _____

City/State: _____

Country _____

Please attached your Suggestion or Article with this form and send it on below given address.

HEAD OFFICE : 2783, 3rd Floor, D. C. Road, Ambala Cantt-133001 Haryana INDIA

BRANCH OFFICE : B-151, Street No. 9, Opp. Ration Shop, Kamal Vihar, Kamaal Pur, Burari, Delhi-110084 INDIA

Tel. : 011-65252725, Mobile : 09213724926, Email : Sharad.labinfo@gmail.com, Website : www.labinfo.in

PRODUCT PROFILE

CUBE MOULD (150 MM)

With advance production equipment, rich technical force, the consummate making technology, the product is of high quality standard.

We have modern and well-equipped Quality Control laboratory which ensures that a series of scrupulous tests are executed at every stage of manufacturing the mould.

Our technically qualified personnel run continual check on the following parameters:

- Distance between opposite faces: 150mm±0.2mm.
- Height of Mould: 150mm±0.2mm
- Planeness of Inside surface: <0.03mm

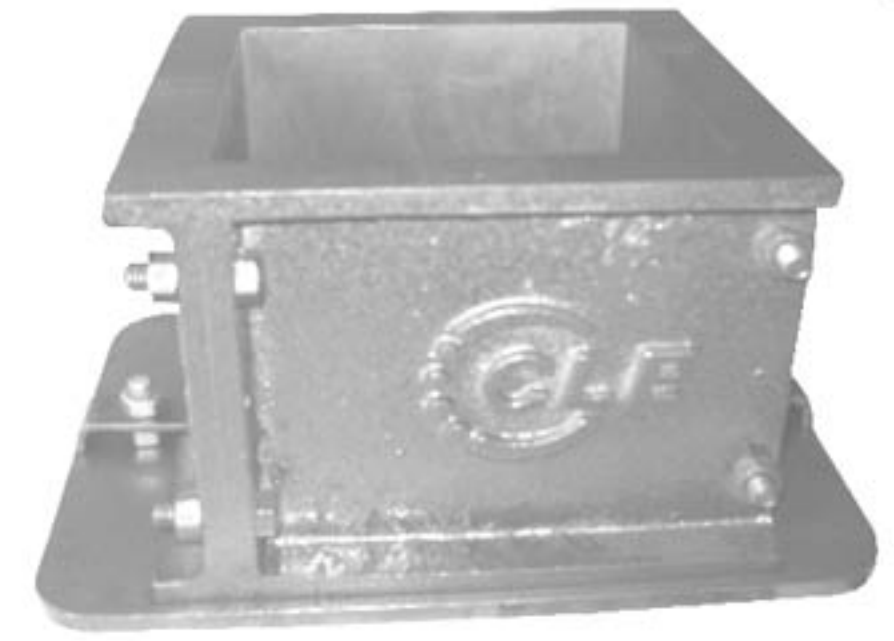

for Further details contact:

CONSAL LABORATORY EQUIPMENTS



• High accuracy and performance

• Click stop digital system.

• Easy calibration and maintenance

• Separate streamlined tip ejector.

• Autoclavable tipcone assembly.

for Further details contact:

IMPULSE INNOVATION

Email: impulseinnovation@gmail.com



First Time
in India

**N2B BATTERY
HYDROMETER**

With

IS : 12950



CM/L-4871580

BATTERY
HYDROMETER



OMSONS

SERVICE AND QUALITY SINCE 1983

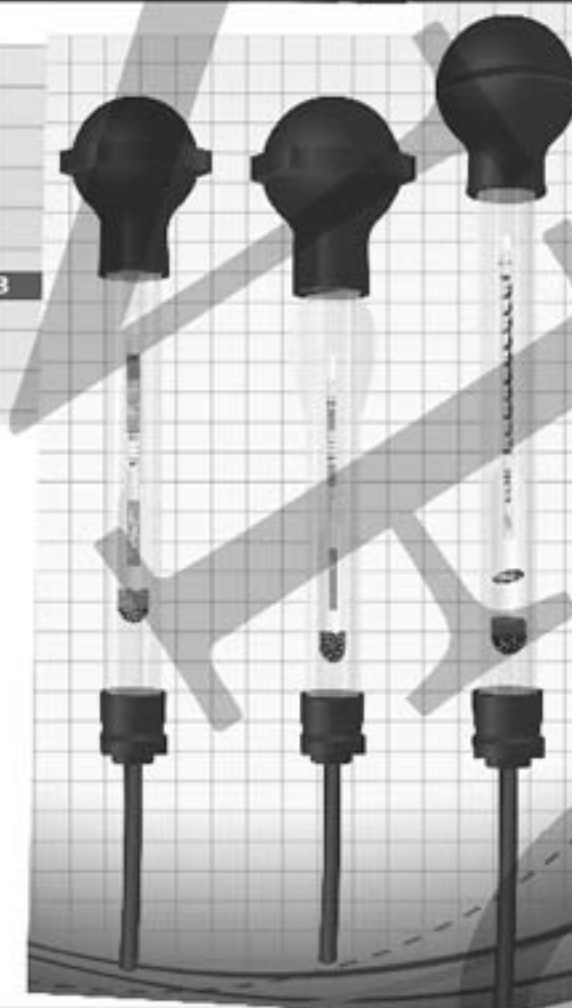

for Further details contact:

**NARINDRA
SCIENTIFIC INDUSTRIES**

Email: omsonsis@gmail.com

Features: Innovated rich oxygen air-acetylene flame analysis technique:

The patented flame analysis technique adopting rich oxygen air-acetylene flame as the substitution for nitrous oxide-acetylene flame for high temperate element analysis, such as Ca, Al, Ba, W, Mo, Ti, V etc. Flame Temperature is continuously adjustable between 2300-2950 °C, which makes it possible to choose the best atomization temperature for different elements. It features easy operation, low analysis cost and wide flame AAS analytical range. Rich oxygen flame will not pollute the environment and is not harmful to human bodies. It's a break through in flame AAS analysis.

for Further details contact:

Labtronics

Email : info@labtronicsindia.com



LT-2100

ATOMIC ABSORPTION SPECTROPHOTOMETER



(1st In INDIA)

FULLY COMPLETE AUTOMATIC MACHINE MADE GLASS TEST TUBE HOUSE



A.P. GALAXY ENTERPRISES

1168, Bengali Mohalla, Ambala Cantt.-133001
Haryana (India) Tel.: +91-171-2601669, 4001769
+91-9466831244, 09896301669,
E-mail : apgalaxy_enterprises@rediffmail.com
Web: www.testtubeindia.com



KWALITY MICRO SCIENTIFIC

An ISO 9001 :2000 Certified Co.



Manufacturer of
Microscopes, Gemological, Software,
Camera & Lab. Instruments

5337, Punjabi Mohalla, Near B.D. High School,
Ambala Cantt-133 001 (Haryana),
Ph.: +91-171-4006034, 4020034, 2632034,
Cell: +91-9466693135,
Email: kwallitymicro@live.com,
Web.: www.kwallitymicro.com

BOOK YOUR ADVERTISEMENT
THIS SPACE

ONE TIME ONLY @ 500/Rs
FOR A YEAR (6 TIME) @ 2500/Rs



PRAGA Instruments Co.

Manufacturers of Scientific Instruments



Contact Persons : U.S. Chauhan (Mob.: 09896077402) Kumar Partap (Mob.: 09813262355)

15, Shakti Nager, Ekta Vihar Road, Near Tangri, Ambala Cantt (Haryana)
Tel : 0171-2654744 Fax : 0171-2691876 Email: pragainstrument@gmail.com

NIKITA INDUSTRIES

2512/8, Bengali Mohalla, Ambala Cantt. (Haryana) INDIA
Phone : 0171 - 4001147, Mobile : 09729446068
e-mail : nikita_industries@yahoo.com

A House of Complete Scientific Laboratory Equipment

WOODEN / M.S. POWDER COATED / STAINLESS STEEL EQUIPMENTS



Zenith Scientific - Lab Instrumentation

Manufacturer & Exporters of : All kinds of ZENITH® Microscope, Microtome,
Overhead Projector, Screens Laboratory instruments & Glassware



Laminar Airflow



CCTV Microscope



Laboratory Glassware and
Thermometers



Thermometers &
Hygrometer

20, Pragati Vihar, Shopping Center, Haridwar Road, Dharampur (E), Dehradun (India)
Ph.: +91-135-6542903, Mob.: +91-9456708547, 9219612903 Telefax : +91-135-2675253
E-mail : info@zenithscientific.com, www.zenithscientific.com



LAB & ENGINEERING CORPORATION

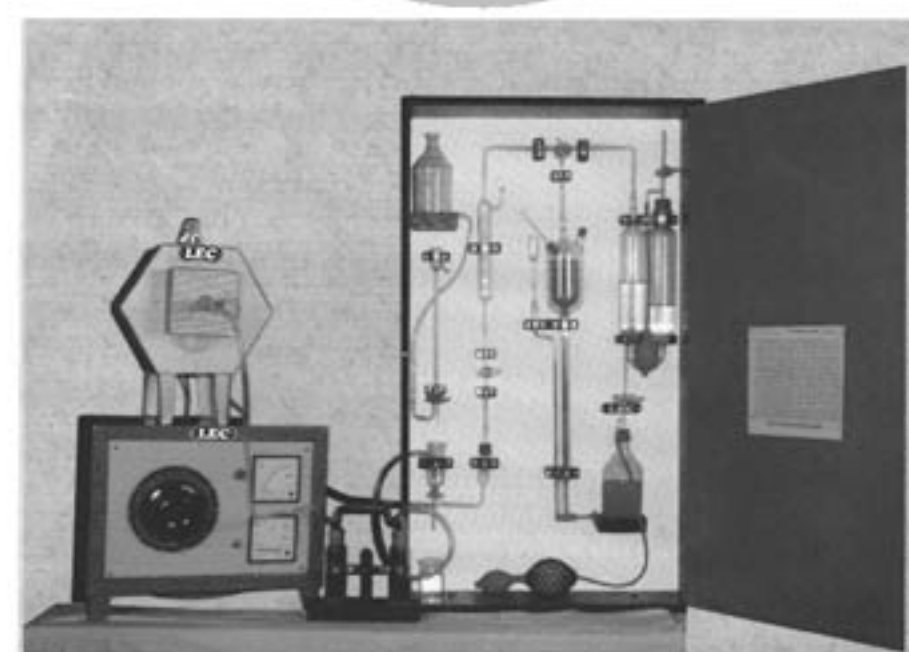

Manufacturers of:
CARBON SULPHUR APPARATUS,
SCIENTIFIC LABORATORY
INSTRUMENTS



343, Badam Wadi, Kalbadevi Road, Mumbai-400 002, Tel.: 2240 0508
Mobile. : 9821408225

KUMAR INSTRUMENTS

Dealer & Exporters of :-
Cooling & Heating Equipments,
Motorized Equipments



54/5911, North Basti Harphool Singh,
Sadar Thana Road, Delhi - 110 006
Tel:- 011-23622552 Mob:- 9899463478
Email: info@kumarinstruments.com
www.kumarinstruments.com





Avi Scientific (India)

Manufactures, Dealers & Exporters of Scientific Laboratory Instruments



Haemometer / Hamoglobinometer



Multimeter



Infrared Thermometer



Whirling Hygrometer (Psychrometer)



Digital Thermometer



Vernier Caliper

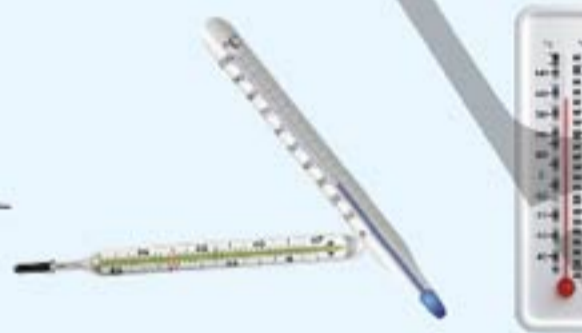

Thermometers



Porcelain Crucible



Micropipettes



Oil Immersion Lens



Vibration Meter



Tachometer



Nickel Ware



Altimeter



Soil PH / Moisture Meter



Infrared Moisture Balance



Quartz Ware



Stop Clock



Micro Slides & Cover Glass



Blood Lancets



Timers



Stage & Ocular Micrometer



Refractometer



Electrode



Thermo Hygograph



Petri Dish



Stopwatch Mechanical



Stopwatch Digital



Crucibles Lids Basins



Micrometer



Soil Testing Kits

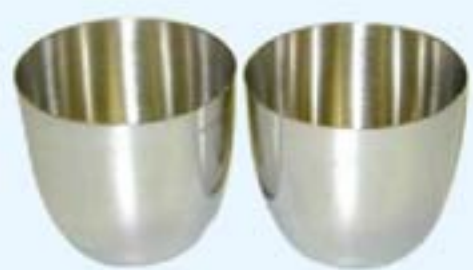

Platinum Ware



Alumina Crucibles



Silicone Grease



Distiller Glass/Quart



Thermo Hygrometer

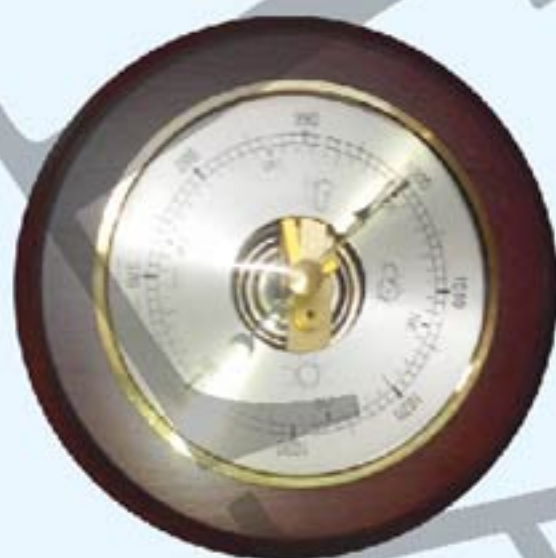

Barometer Mechanical



Tong Tester (Clamp Meter)



Manometer



Digital Barometer



Anemometer



Lux Meter U. V. Meter



Digital Distance Meter



Alcohol Breath Analyzer



Membrane Filter Assembly



Sound Level Meter



Hydrometer



Grain Moisture Meter



Water Testing Kits



Lemico Hydrometer



Test Sieves



Hand Held Metal Detector



Ultraviolet Cabinet



Vacuum Pump (Oil Seal High Vacuum)



Ultrasonic Bath



Avi Scientific (India)

Amar Gian Industrial Estate, A - 221, Opp. Khopat S. T. Stand, L.B.S. Marg, Thane (W) Mumbai - 400 601 India

Office No : + 91 022 2547 7638, Tele Fax : + 91 022 2547 7638

Email Id : md@aviscientific.com, aviscientific@yahoo.co.in Web : www.aviscientific.com



Pragati Scientific Industry

Manufacturer & Exporter of Laboratory Glassware

An ISO 9001:2008 Certified Organization



59, Vill. Manglai, P. O. Khudda Kalan-133003, Distt. Ambala, Haryana (INDIA)
Tel. : 0171- 4003201, Mobile : 09896789201
Email : info@pragatilab.com, Website : www.pragatilab.com



BR Biochem Life Sciences Pvt. Ltd.

An ISO 9001 : 2008 Certified Company

Complete Range of Biotechnology and Laboratory instruments, plasticware, DNA/RNA Kits, Elisa Kits, Antibodies, Biochemicals and Reagents.



pH Meter



Dry Bath Incubator



Refrigerated Centrifuge



Protein Electrophoresis



Orbital Shaker



Gel Documentation System



Ultrasonic Bath



Seed Counter



Hot Plate



LCD Microscope

We are looking distributors, please contact us

1/10, F.F, Tilak Nagar, Near Tilak Nagar Metro Station, New Delhi-110018, INDIA
Phone: +91-11-43033662,43033664, E-mail: info@brbls.com, Web.: www.brbls.com



KWALITY MICRO SCIENTIFIC



Cell: +91-9466693135
(Gourav Verma)

An ISO 9001:2008 Certified Co.



Binocular Microscope

Student Microscope

Binocular Microscope



Microscope Software

Digital Camera

Projection Microscope

Inverted Metallurgical Microscope



Manufacturers of

All Type Research, School & Collage Microscopes

5337, Punjabi Mohalla, Near B.D. High School, Ambala Cantt-133 001 (Haryana) INDIA
Ph.: +91-171-4006034, 4020034, 2632034, Cell: +91-9466693135,
Email: kwalitymicro@live.com, Web.: www.kwalitymicroscope.com



IMPULSE INNOVATION

Manufacturer & Exporter of Micropipette & Plastic Lab Ware



687, MALKA GANJ MAIN ROAD, DELHI-110007 INDIA

Tel.: (O) +91-11-23854233 (M) +91-9811147847

Email: impulseinnovation@gmail.com

Website: www.impulseinnovation.in

Microscopes, Software & Camera

Manufacturers of

Research Pathological Microscopes, Research Trinocular Microscope, Phase Contrast Microscope, Penta Microscope, Ore Microscope, Metallurgical Microscope, Led Microscope(Cordless), Dual View Microscope, Multi Viewing Microscopes, Stereo Microscopes, Single Nose Microscope, Stereo Microscope(Student), Stereo Zoom Microscopes, Research Medical Microscopes & All Type Research School Lable, Collage Lable Microscopes .



3704/B, Panna Cottage, Near Civil Hospital, Ambala Cantt-133001 INDIA
Tel. : 0171- 4008809, 4008056, Email : guarav9060@gmail.com,
bhanu_amb@yahoo.com, Web. : www.microscopesaccessories.com

Manufacturer of :



AN ISO 9001 : 2008 CERTIFIED COMPANY
"Thakur Niwas", 2778, D.C. Road, Ambala Cantt-133001 (Haryana) India, Tel.: +91-171-2641461, 2643049
Fax No.: +91-171-2640461, 09416224380, E-mail: elitescientific@vsnl.net, Web: www.elitescientific.com



Any quiry
Email : sharad.labinfo@gmail.com
Call : 09213724926

A BI -MONTHLY BUYER'S GUIDE ISSUE FOCUS ON ANALYTICAL, DIAGNOSTIC, LABORATORY & SCIENTIFIC INDIAN & INTERNATIONAL INDUSTRY

get Free Copy Now

Contents of the BUYER'S GUIDE

- ☀ New Products/Products launch
- ☀ Products Write-up
- ☀ New Distributor /Agency/Dealers Ship
- ☀ Exhibition/Events
- ☀ Supplier Listing
- ☀ Products Listing
- ☀ Advertisements

YEARLY DISTRIBUTE THIS EXHIBITION

Lab-Info
18 January 2012 A BI-MONTHLY ISSUE FOCUS ON ANALYTICAL, LABORATORY & SCIENTIFIC INDUSTRY SPECIAL EDITION FOR AMAL LAB 2012, DELHI

Topmost Instruments Corp. of India
EXPORTS, IMPORTERS & MANUFACTURERS
OPHTHALMIC, E.N.T., MEDICAL & SURGICAL EQUIPMENT
4694, Opp. Vignya Bazar, Cross Road H/o. S. Ambala Cantt-133001 (HARYANA) INDIA
Tel. : +91-171-4008598, 4008056, E-mail: topmostindia@gmail.com
Mobile : 09904042598, 09196829655

ACE MEDICAL CORPORATION
MANUFACTURER & EXPORTER OF
ALL KINDS OF AUTOCLAVES & STERILIZERS
A-1345, Sill No. 15, Seem Bazar, South Gurgaon (Haryana), Delhi-110029
Mobile : +91-9999755226, Email: acecorpn@rediffmail.com
Website: www.acemedicalcorp.com

LYZER Techno Scientific Instruments
MANUFACTURERS & EXPORTERS
Office : # 4070, Sorafo Bazar, Ambala Cantt-130001 (Haryana) INDIA, Phone : 0171-2653426, 3244001, Telefax : 0171-2653426
Mob:+91-9896321375, 9416734554, E-mail : lyzer2004@yahoo.com, lyzer@lyzerindia.com, lyzer@rediffmail.com, Website : www.lyzerindia.com

ULTIMATE HOSPICARE
Manufacture & Export of Hospital Furniture & Medical Equipments

BIOTECHNOLOGIES INC
At 102, 301, Centre C.E. 25

Advertising Rates	
Position	Rate Per Insertion
Cover Section :-	RS / US\$
Front Cover Page	25,000 / 455
Second Cover Page	20,000 / 365
Third Cover Page	20,000 / 365
Back Cover Page	20,000 / 365
Colour Section :-	
Full Colour Page	15,000 / 250
Half Colour Page	8,000 / 125
Quarter Colour Page	4,000 / 65
Black & White Section :-	
Full B/W Page	8,000 / 125
Half B/W Page	4,000 / 65
Quarter B/W Page	2000 / 40

LAB INFO

HEAD OFFICE : 2783, 3rd Floor, D. C. Road, Ambala Cantt-133001 Haryana INDIA
BRANCH OFFICE : B-151, Street No. 9, Opp. Ration Shop, Kamal Vihar, Kamaal Pur, Burari, Delhi-110084 INDIA
Tel. : 011-65252725, Mobile : 09213724926, Email : Sharad.labinfo@gmail.com, Web. : www.labinfo.in

MANUFACTURER & EXPORTER OF:

Biology, Chemistry, Physics Lab Equipments, Audio Visual Products, Pharmacy Lab Equipments, Analytical Instruments, Electronic Instruments, Educational Lab Instruments, Fibre Glass Model, Lab Plasticware & Lab Glassware



1589, Kacha Bazar, Ambala Cantt., Haryana-133001, India
Tel.: 91-171-2619739, 4001111, Mobile: 09416070079,
Email: info@rupaliinstruments.com, www.rupaliinstruments.com

Manufacturers & Exporters of
Anatomy, Educational, Biological,
Zoological, Botanical, Medical, Nursing,
Osteology, Geography Models,
Skeletons & Charts in India.

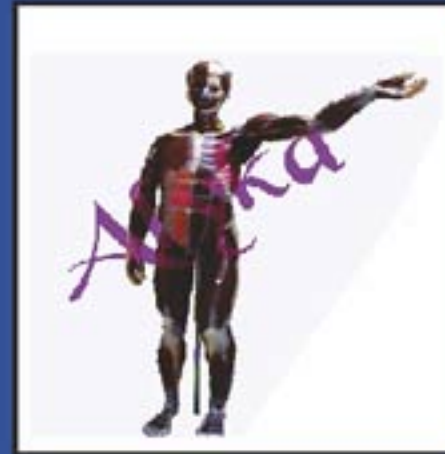

83E/1, Rani Bagh, Ambala Cantt. -133001 Haryana INDIA
Tel. : +91-171-2650111, Mobile : +91- 9729490001
Email : info@alykamodels.com, Web. : www.alykamodels.com

BOOK YOUR ADVERTISEMENT

THIS SPACE

ONE TIME ONLY @ 1000/Rs

FOR A YEAR (6 TIME) @ 5000/Rs

Glassea

LAB GLASSEA

Manufacturers and Suppliers of
Laboratory Glassware like Beakers, Flasks,
Funnels, P.T.F.E. Key Stop Cocks, Volumetric Glassware, Burettes



E-mail : labglassea@gmail.com
(INDIA)



HOLY SCIENTIFIC ENTERPRISES

Specialist In All Type of Recording Drum, Perimeter & Pharmacy Instruments

Office: JANDLI KANWLA ROAD, JANDLI, MODEL TOWN, AMBALA CITY-134003 (INDIA)
Works: 344-B, HSIIDC, Saha, Ambala, Haryana, TEL: +91-171-2801179, Mob.: +91-9896219922
Brach Off.: Powai, Mumbai-400076, Ph.: +91-22-25707749, Mob: +91-9320164318,
Email: holyscientific54@gmail.com Web : www.holylab.in

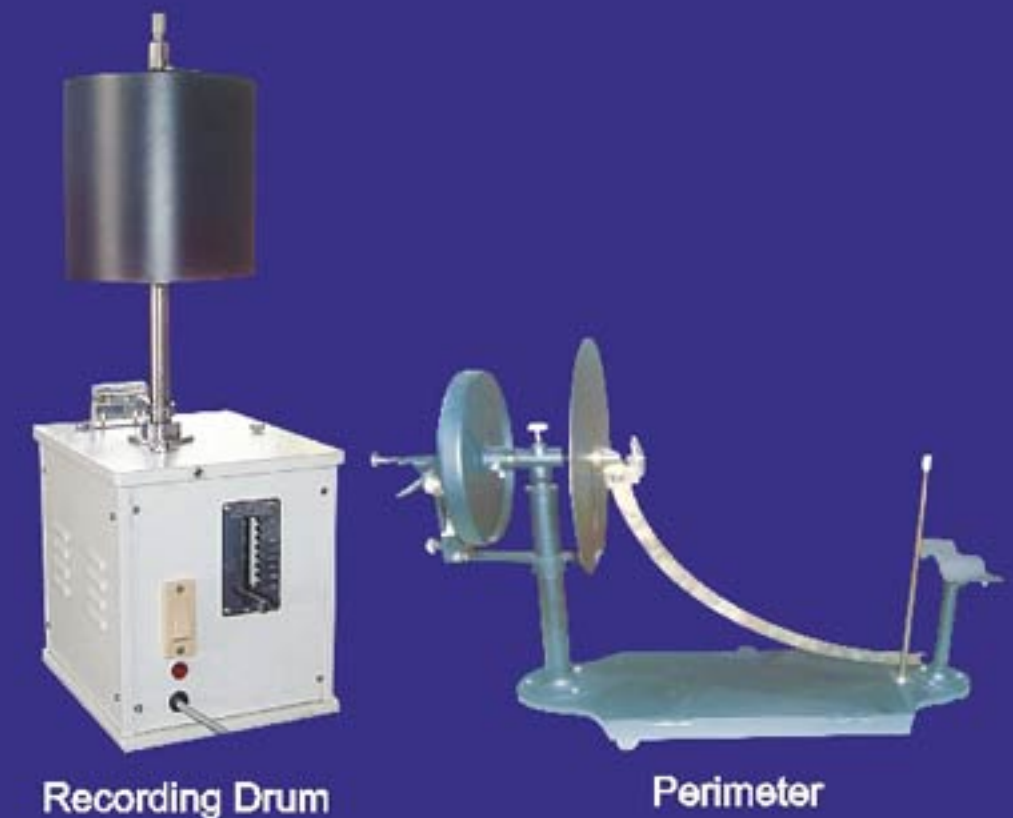

MODERN APPLIANCES

MANUFACTURER & EXPORTER

Shop No. 23, Science Market, Opp. Hargolal Dharamshala, Ambala Cantt.
Ph.: 0171-4000386, Mob.: 9896497004, 9034943143

AN ISO
9001:2008
CERTIFIED CO.



Works : 64, 1st Floor, Satsang Vihar, Behind B.D. Floor Mill, Ambala Cantt., Email: anusandhan_india@yahoo.com



Manufacturer, Exporter & Supp. of :
Research Based Standard And Customized Lab
Equipments Engineering Science & Technology

Our Products Range :-

- Math Lab Instruments
- Geography Teaching Experiments
- High School Experiment
- Charts & Models
- Electronics & Electrical Testing Equipments
- Educational Trainer
- Laboratory Equipments
- Clean Room Equipments
- Autoclaves
- Oil and Petroleum Testing Instruments
- Pharmacy Lab Equipments
- Entomological Equipments
- Testing Equipments
- Civil & Survey Engineering Equipments

ATCO™ ADVANCED TECHNOCRACY INC.

Atico House, 5309, Grain Market, Near B D Sen. Sr. School, Ambala Cantt -133001 Hr (INDIA)
Tel: +91-171 4004736 | Fax: +91-171 4007718 | Mb : +91-9896793832, +91-9996186555
Email: aticoindia@gmail.com | Web : www.aticoexport.com



Manufacturer & Exporter of
Scientific & Laboratory Glasswares



- Beaker ● Bottles-Reagent ● Condensers ● Measuring Cylinders ● Desiccators
- Petri Dish ● Distillation Apparatus ● Extraction Apparatus ● Flasks ● Funnels
- Pipettes ● Test Tubes ● Slides ● Silica Wares ● Watch Glass ● Kipps Apparatus
- Amber Colour Glassware ● Customize Glassware



Glastron Laboratory Equipments

An ISO 9000:2008 Certified Company

120, Housing Board Colony, Ambala Cantt - 133 001 Haryana INDIA
Tel : +91-171-4020222 Fax : +91-171-4020333 Mobile: +91-9813700333
Email: info@glastron.in Website : www.glastron.in